



Grayhill, Inc.

62S11-M5-020CH

Número de pieza:

62S11-M5-020CH

Fabricante / Marca:

Grayhill, Inc.

Descripción del producto

ROTARY ENCODER OPTICAL 32PPR

Hojas de datos:

[PDF 62S11-M5-020CH.pdf](#)

Estado de RoHS

 Sin plomo / Cumple con RoHS

Nave de

Hong Kong

Manera del envío

DHL/Fedex/TNT/UPS/EMS

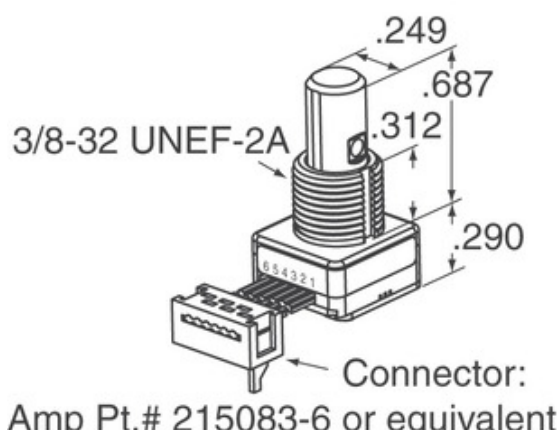

La imagen puede ser representación. Ver especificaciones para detalles del producto.

[SOLICITUD DE PRESUPUESTO](#)







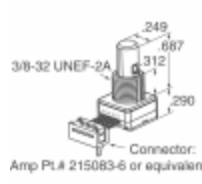

Especificaciones de 62S11-M5-020CH

NÚMERO DE PIEZA	62S11-M5-020CH
FABRICANTE	Grayhill, Inc.
DESCRIPCIÓN	ROTARY ENCODER OPTICAL 32PPR
ESTADO LIBRE DE PLOMO / ESTADO ROHS	Sin plomo / Cumple con RoHS
FICHA DE DATOS	PDF 62S11-M5-020CH.pdf
SUMINISTRO DE VOLTAJE	5V
ESTILO DE TERMINACIÓN	Cable with Connector
SERIE	62S
VIDA DE ROTACIÓN (CICLOS POR MINUTOS)	1M
PULSOS POR REVOLUCIÓN	32
TIPO DE SALIDA	Quadrature (Incremental)
OTROS NOMBRES	62S11M5020CH
ORIENTACIÓN	Vertical
TIPO DE MONTAJE	Panel Mount
NIVEL DE SENSIBILIDAD A LA HUMEDAD (MSL)	1 (Unlimited)
TIEMPO DE ENTREGA ESTÁNDAR DEL FABRICANTE	8 Weeks
ESTADO SIN PLOMO / ESTADO ROHS	Lead free / RoHS Compliant
TIPO DE CODIFICADOR	Optical
FIJADOR	Yes
INTERRUPTOR INCORPORADO	Yes
TIPO DE ACTUADOR	1/4" Dia Flatted End

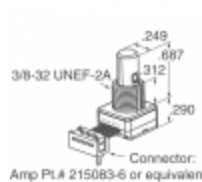
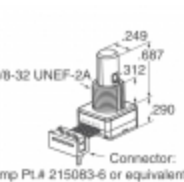
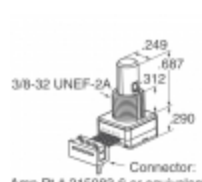
Tags relacionados

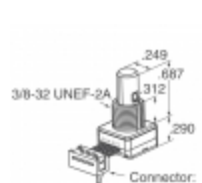
Grayhill, Inc. 62S11-M5-020CH	Distribuidor 62S11-M5-020CH	Proveedor 62S11-M5-020CH
Precio 62S11-M5-020CH	62S11-M5-020CH Imágenes	Imagen 62S11-M5-020CH
Hoja de datos PDF 62S11-M5-020CH	62S11-M5-020CH Descargar hoja de datos	Hoja de datos 62S11-M5-020CH
Stock 62S11-M5-020CH	Compra 62S11-M5-020CH	Comprar Grayhill, Inc. 62S11-M5-020CH
Grayhill, Inc. 62S11-M5-020CH	Proveedor Grayhill, Inc.	Distribuidor Grayhill, Inc.
Grayhill, Inc. 62S11-M5-020CH	Grayhill Inc. 62S11-M5-020CH	

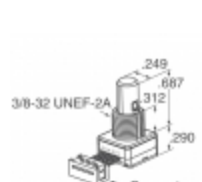
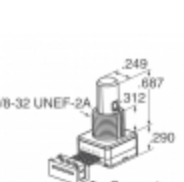
Productos relacionados

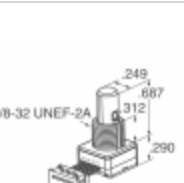
 <p>62S11-M5-040C Fabricantes: Grayhill, Inc. Descripción: ROTARY ENCODER OPTICAL 32PPR En stock: Out stock</p> <p>RFQ</p>	 <p>62S11-M5-020C Fabricantes: Grayhill, Inc. Descripción: ROTARY ENCODER OPT 32PPR 2" CBL En stock: Out stock</p> <p>RFQ</p>
 <p>62S11-M0-PV Fabricantes: Grayhill, Inc. Descripción: ROTARY ENCODER OPTICAL 32PPR En stock: Out stock</p> <p>RFQ</p>	 <p>62S11-M5-030CH Fabricantes: Grayhill, Inc. Descripción: ROTARY ENCODER OPTICAL 32PPR En stock: Out stock</p> <p>RFQ</p>
 <p>62S11-M0-200S Fabricantes: Grayhill, Inc. Descripción: ROTARY ENCODER OPTICAL 32PPR En stock: Out stock</p> <p>RFQ</p>	 <p>62S11-M5-050C Fabricantes: Grayhill, Inc. Descripción: ROTARY ENCODER OPT 32PPR 5" CBL En stock: 558 pcs</p> <p>RFQ</p>
 <p>62S11-M5-030C Fabricantes: Grayhill, Inc. Descripción: ROTARY ENCODER OPTICAL 32PPR En stock: Out stock</p> <p>RFQ</p>	 <p>62S11-M0-210SH Fabricantes: Grayhill, Inc. Descripción: ROTARY ENCODER OPT 32PPR 20" CBL En stock: Out stock</p> <p>RFQ</p>
 <p>62S11-M5-020S Fabricantes: Grayhill, Inc. Descripción: ROTARY ENCODER OPTICAL 32PPR En stock: Out stock</p> <p>RFQ</p>	 <p>62S11-M5-020SH Fabricantes: Grayhill, Inc. Descripción: ROTARY ENCODER OPT 32PPR 2" CBL En stock: Out stock</p> <p>RFQ</p>
 <p>62S11-M0-P Fabricantes: Grayhill, Inc. Descripción: ROTARY ENCODER OPTICAL 32PPR En stock: Out stock</p> <p>RFQ</p>	 <p>62S11-M0-PH Fabricantes: Grayhill, Inc. Descripción: ROTARY ENCODER OPTICAL 32PPR En stock: Out stock</p> <p>RFQ</p>