



Grayhill, Inc.

62S11-H9-060SH

Número de pieza:

62S11-H9-060SH

Fabricante / Marca:

Grayhill, Inc.

Descripción del producto

ROTARY ENCODER OPTICAL 32PPR

Hojas de datos:

 62S11-H9-060SH.pdf

Estado de RoHS

 Sin plomo / Cumple con RoHS

Nave de

Hong Kong

Manera del envío

DHL/Fedex/TNT/UPS/EMS

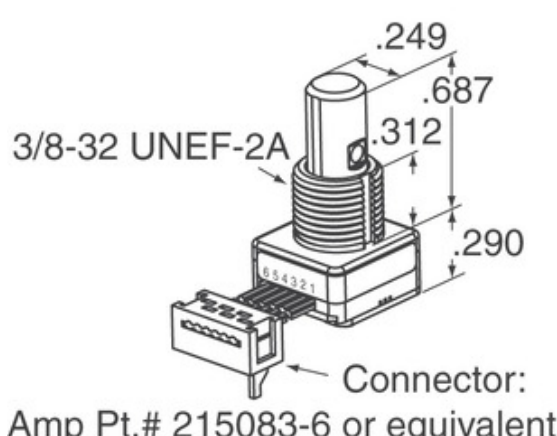

Connector:
Amp Pt.# 215083-6 or equivalent

La imagen puede ser representación. Ver especificaciones para detalles del producto.

[SOLICITUD DE PRESUPUESTO](#)





Especificaciones de 62S11-H9-060SH

| | |
|---|--|
| NÚMERO DE PIEZA | 62S11-H9-060SH |
| FABRICANTE | Grayhill, Inc. |
| DESCRIPCIÓN | ROTARY ENCODER OPTICAL 32PPR |
| ESTADO LIBRE DE PLOMO / ESTADO ROHS | Sin plomo / Cumple con RoHS |
| FICHA DE DATOS |  62S11-H9-060SH.pdf |
| SUMINISTRO DE VOLTAJE | 5V |
| ESTILO DE TERMINACIÓN | Cable Leads |
| SERIE | 62S |
| VIDA DE ROTACIÓN (CICLOS POR MINUTOS) | 1M |
| PULSOS POR REVOLUCIÓN | 32 |
| TIPO DE SALIDA | Quadrature (Incremental) |
| OTROS NOMBRES | 62S11H9060SH |
| ORIENTACIÓN | Vertical |
| TIPO DE MONTAJE | Panel Mount |
| NIVEL DE SENSIBILIDAD A LA HUMEDAD (MSL) | 1 (Unlimited) |
| TIEMPO DE ENTREGA ESTÁNDAR DEL FABRICANTE | 8 Weeks |
| ESTADO SIN PLOMO / ESTADO ROHS | Lead free / RoHS Compliant |
| TIPO DE CODIFICADOR | Optical |
| FIJADOR | Yes |
| INTERRUPTOR INCORPORADO | Yes |
| TIPO DE ACTUADOR | 1/4" Dia Flatted End |

Tags relacionados

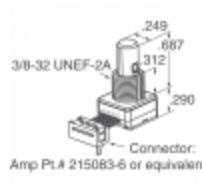
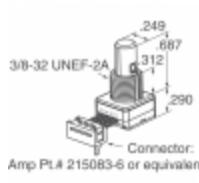
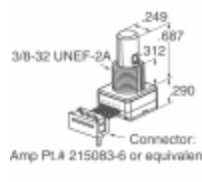
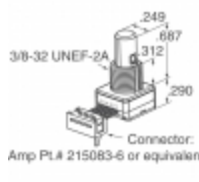
| | | |
|----------------------------------|--|---------------------------------------|
| Grayhill, Inc. 62S11-H9-060SH | Distribuidor 62S11-H9-060SH | Proveedor 62S11-H9-060SH |
| Precio 62S11-H9-060SH | 62S11-H9-060SH Imágenes | Imagen 62S11-H9-060SH |
| Hoja de datos PDF 62S11-H9-060SH | 62S11-H9-060SH Descargar hoja de datos | Hoja de datos 62S11-H9-060SH |
| Stock 62S11-H9-060SH | Compra 62S11-H9-060SH | Comprar Grayhill, Inc. 62S11-H9-060SH |
| Grayhill, Inc. 62S11-H9-060SH | Proveedor Grayhill, Inc. | Distribuidor Grayhill, Inc. |
| Grayhill, Inc. 62S11-H9-060SH | Grayhill Inc. 62S11-H9-060SH | |

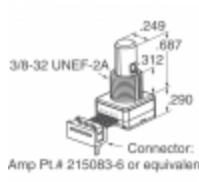
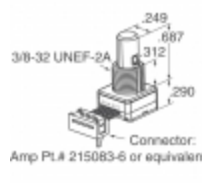
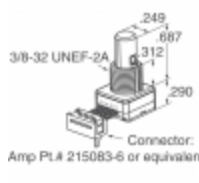
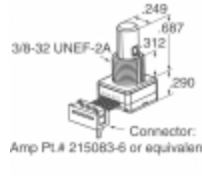
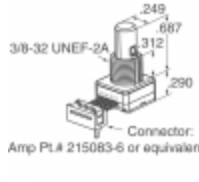
Productos relacionados

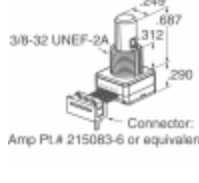
| | |
|--|---|
|  <p>62S11-L0-040C Fabricantes: Grayhill, Inc. Descripción: ROTARY ENCODER OPTICAL 32PPR En stock: Out stock</p> <p>RFQ</p> |  <p>62S11-H9-050S Fabricantes: Grayhill, Inc. Descripción: ROTARY ENCODER OPTICAL 32PPR En stock: Out stock</p> <p>RFQ</p> |
|  <p>62S11-L0-020C Fabricantes: Grayhill, Inc. Descripción: ROTARY ENCODER OPTICAL 32PPR En stock: Out stock</p> <p>RFQ</p> |  <p>62S11-L0-020CH Fabricantes: Grayhill, Inc. Descripción: ROTARY ENCODER OPTICAL 32PPR En stock: Out stock</p> <p>RFQ</p> |
|  <p>62S11-L0-040S Fabricantes: Grayhill, Inc. Descripción: ROTARY ENCODER OPT 32PPR 4" CBL En stock: Out stock</p> <p>RFQ</p> |  <p>62S11-H9-040S Fabricantes: Grayhill, Inc. Descripción: ROTARY ENCODER OPTICAL 32PPR En stock: Out stock</p> <p>RFQ</p> |
|  <p>62S11-H9-020S Fabricantes: Grayhill, Inc. Descripción: ROTARY ENCODER OPTICAL 32PPR En stock: Out stock</p> <p>RFQ</p> |  <p>62S11-H9-P Fabricantes: Grayhill, Inc. Descripción: ROTARY ENCODER OPTICAL 32PPR En stock: Out stock</p> <p>RFQ</p> |
|  <p>62S11-H9-PH Fabricantes: Grayhill, Inc. Descripción: ROTARY ENCODER OPTICAL 32PPR En stock: Out stock</p> <p>RFQ</p> |  <p>62S11-H9-025S Fabricantes: Grayhill, Inc. Descripción: ROTARY ENCODER OPTICAL 32PPR En stock: Out stock</p> <p>RFQ</p> |
|  <p>62S11-H9-060C Fabricantes: Grayhill, Inc. Descripción: ROTARY ENCODER OPTICAL 32PPR En stock: Out stock</p> <p>RFQ</p> |  <p>62S11-H9-040C Fabricantes: Grayhill, Inc. Descripción: ROTARY ENCODER OPTICAL 32PPR En stock: Out stock</p> <p>RFQ</p> |