

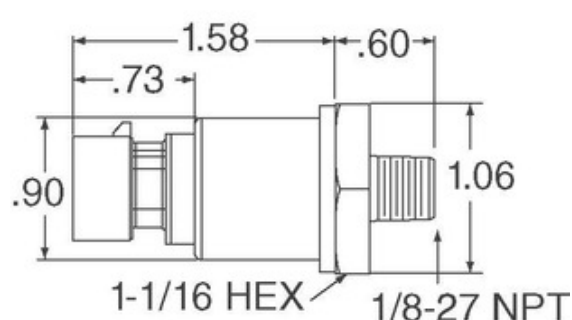

Honeywell Sensing and

Productivity Solutions



MLH010BGG01B

Número de pieza:

MLH010BGG01B

Fabricante / Marca:

Honeywell Sensing and Productivity Solutions

Descripción del producto

MLH ALL METAL PRESS SENSE -ATF

Hojas de datos:

[1.MLH010BGG01B.pdf](#)
[2.MLH010BGG01B.pdf](#)

Estado de RoHS

 Sin plomo / Cumple con RoHS

Nave de

Hong Kong

Manera del envío

DHL/Fedex/TNT/UPS/EMS

[SOLICITUD DE PRESUPUESTO](#)

La imagen puede ser representación. Ver especificaciones para detalles del producto.



Especificaciones de MLH010BGG01B

NÚMERO DE PIEZA	MLH010BGG01B
FABRICANTE	Honeywell Sensing and Productivity Solutions
DESCRIPCIÓN	MLH ALL METAL PRESS SENSE -ATF
ESTADO LIBRE DE PLOMO / ESTADO ROHS	Sin plomo / Cumple con RoHS
FICHA DE DATOS	1.MLH010BGG01B.pdf 2.MLH010BGG01B.pdf
SUMINISTRO DE VOLTAJE	9.5 V ~ 30 V
PAQUETE DEL DISPOSITIVO	-
SERIE	MLH
TIPO DE PRESIÓN	Vented Gauge
ESTILO DE PUERTO	Threaded
TAMAÑO DEL PUERTO	Male - 1/4" (6.35mm) NPT
PAQUETE / CUBIERTA	Cylinder, Metal
TIPO DE SALIDA	Analog Current
SALIDA	4 mA ~ 20 mA
TEMPERATURA DE FUNCIONAMIENTO	-40°C ~ 125°C
PRESIÓN OPERACIONAL	145.04 PSI (1000 kPa)
NIVEL DE SENSIBILIDAD A LA HUMEDAD (MSL)	1 (Unlimited)
MÁXIMA PRESIÓN	435.11 PSI (3000 kPa)
TIEMPO DE ENTREGA ESTÁNDAR DEL FABRICANTE	10 Weeks
ESTADO SIN PLOMO / ESTADO ROHS	Lead free / RoHS Compliant
CARACTERÍSTICAS	Amplified Output, Temperature Compensated
DESCRIPCIÓN DETALLADA	Pressure Sensor 145.04 PSI (1000 kPa) Vented Gauge Male - 1/4" (6.35mm) NPT 4 mA ~ 20 mA Cylinder, Metal
EXACTITUD	±0.25%

Tags relacionados

Honeywell Sensing and Productivity Solutions MLH010BGG01B	Distribuidor MLH010BGG01B	Proveedor MLH010BGG01B
Precio MLH010BGG01B	MLH010BGG01B Imágenes	Imagen MLH010BGG01B
Hoja de datos PDF MLH010BGG01B	MLH010BGG01B Descargar hoja de datos	Hoja de datos MLH010BGG01B
Stock MLH010BGG01B	Compra MLH010BGG01B	Comprar Honeywell Sensing and Productivity Solutions MLH010BGG01B
Honeywell Sensing and Productivity Solutions MLH010BGG01B	Proveedor Honeywell Sensing and Productivity Solutions	Distribuidor Honeywell Sensing and Productivity Solutions
Honeywell Sensing and Productivity Solutions MLH010BGG01B	HONEYWELL MLH010BGG01B	Honeywell Sensing and Control EMEA MLH010BGG01B
Honeywell Sensing and Productivity Solutions T&M MLH010BGG01B		

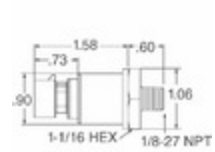
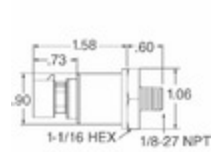
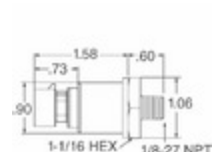
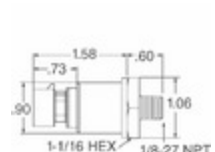
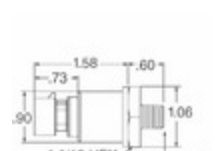
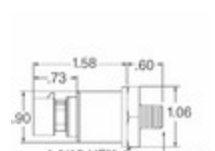
Productos relacionados

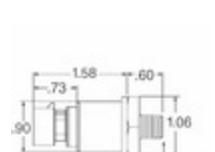
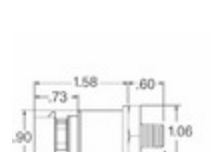
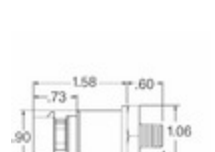
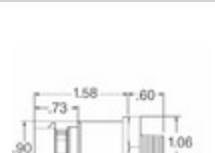
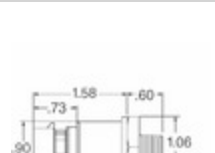
 <p>MLH010BGD18B Fabricantes: Honeywell Sensing and Productivity Solutions Descripción: SENSOR GAUGE 0-10 BAR En stock: Out stock</p> <p>RFQ</p>	 <p>MLH010BGP01B Fabricantes: Honeywell Sensing and Productivity Solutions Descripción: MLH ALL METAL PRESS SENSE -ATF En stock: Out stock</p> <p>RFQ</p>
 <p>MLH010BGD18A Fabricantes: Honeywell Sensing and Productivity Solutions Descripción: SENSOR GAUGE 0-10 BAR En stock: Out stock</p> <p>RFQ</p>	 <p>MLH010BGL14B Fabricantes: Honeywell Sensing and Productivity Solutions Descripción: SENSOR GAUGE 0-10 BAR En stock: Out stock</p> <p>RFQ</p>
 <p>MLH010BGG14B Fabricantes: Honeywell Sensing and Productivity Solutions Descripción: MLH ALL METAL PRESS SENSE -ATF En stock: Out stock</p> <p>RFQ</p>	 <p>MLH010BGD15E Fabricantes: Honeywell Sensing and Productivity Solutions Descripción: SENSOR GAUGE 0-10 BAR En stock: Out stock</p> <p>RFQ</p>
 <p>MLH010BGT14A Fabricantes: Honeywell Sensing and Productivity Solutions Descripción: SENSOR GAUGE 0-10 BAR En stock: Out stock</p> <p>RFQ</p>	 <p>MLH010BGD18E Fabricantes: Honeywell Sensing and Productivity Solutions Descripción: SENSOR GAUGE 0-10 BAR En stock: Out stock</p> <p>RFQ</p>
 <p>MLH010BGM06B Fabricantes: Honeywell Sensing and Productivity Solutions Descripción: MLH ALL METAL PRESS SENSE -ATF En stock: Out stock</p> <p>RFQ</p>	 <p>MLH010BGD15A Fabricantes: Honeywell Sensing and Productivity Solutions Descripción: SENSOR GAUGE 0-10 BAR En stock: Out stock</p> <p>RFQ</p>
 <p>MLH010BGG20B Fabricantes: Honeywell Sensing and Productivity Solutions Descripción: MLH ALL METAL PRESS SENSE -ATF En stock: Out stock</p> <p>RFQ</p>	 <p>MLH010BGD15B Fabricantes: Honeywell Sensing and Productivity Solutions Descripción: SENSOR GAUGE 0-10 BAR En stock: Out stock</p> <p>RFQ</p>