

## Peak Emission Wavelength: 810nm

The MTE2081-OH5 consists of a 810nm high output infrared die in a water-clear 5mm plastic molded package. Custom package solutions and sorting are available.

### FEATURES

- > High Output Power
- > Narrow Beam Angle
- > High Reliability
- > Excellent Optical / Mechanical Axis Alignment

### APPLICATIONS

- > Optical Switches & Sensors
- > Optical Position Sensing / Security Systems
- > Medical Applications / Optical Communication
- > Currency Validation / Light Curtain

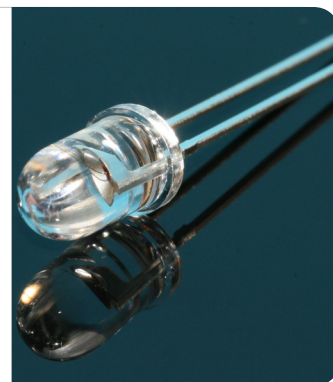

## Absolute Maximum Ratings (Ta=25°C)



ITEMS	SYMBOL	RATINGS	UNIT
Forward Current (DC)	IF	100	mA
Forward Current (Pulse)*1	IFP	1	A
Reverse Voltage	VR	5	V
Power Dissipation	PD	180	mW
Operating Temperature Range	Topr	-20 ~ +80	°C
Storage Temperature Range	Tstg	-30 ~ +100	°C
Junction Temperature	Tj	100	°C
Lead Soldering Temperature*2	Tls	260	°C

\*1: Tw=10μsec, T=10msec. \*2: Time 5Sec max, Position: Up to 3mm from the body.

## Electrical & Optical Characteristics (Ta = 25°C)

ITEMS	SYMBOL	CONDITIONS	MIN	TYP	MAX	UNIT
Power Output	PO	IF=50mA	--	20.0	--	mW
Forward Voltage	VF	IF=50mA	--	1.55	1.9	V
Reverse Current	IR	VR=5V	--	--	100	μA
Peak Emission Wavelength	λp	IF=50mA	--	810	--	nm
Spectral Line Half Width	Δλ	IF=50mA	--	40	--	nm
Half Intensity Beam Angle	Θ	IF=50mA	--	±7	--	deg

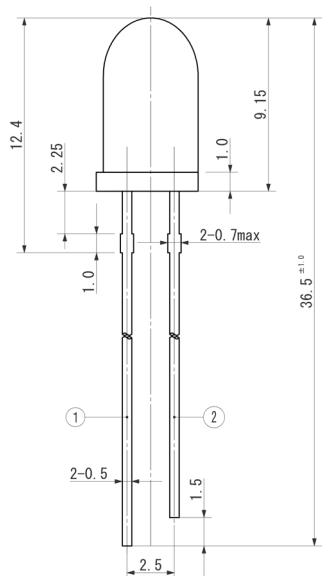

SPECTRAL OUTPUT

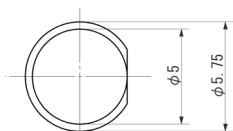
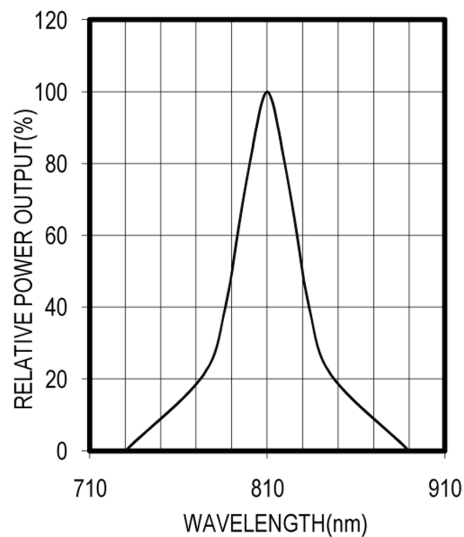

FORWARD I-V CHARACTERISTICS

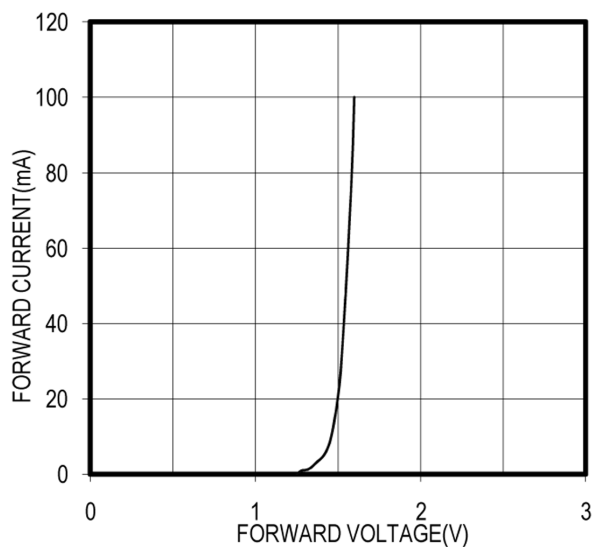

Unit: mm, Tolerance:  $\pm 0.2$

RELATIVE POWER vs FORWARD CURRENT

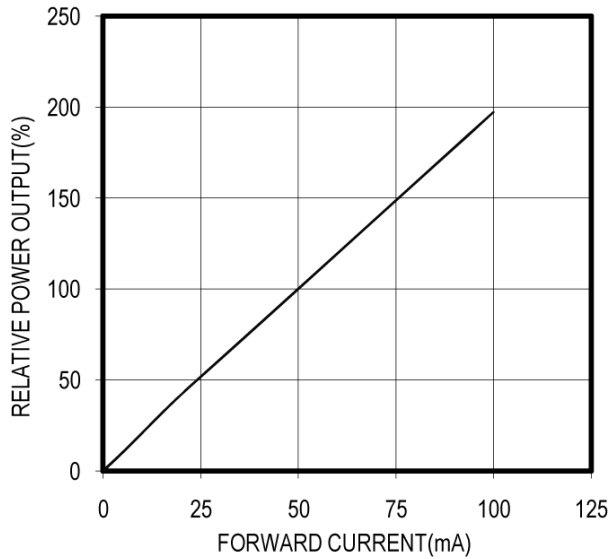

RADIATION PATTERN

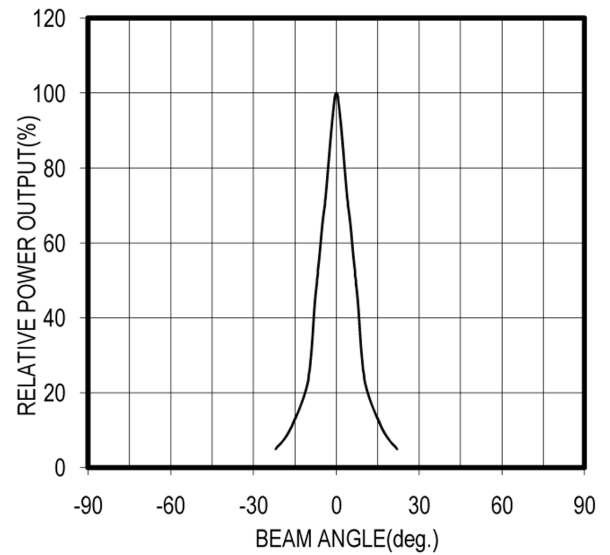

THERMAL DERATING CURVE

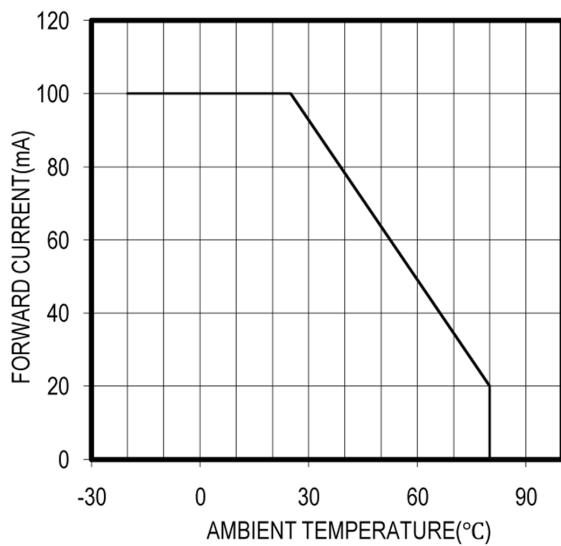

The information contained herein is subject to change without notice.

2011-02-16