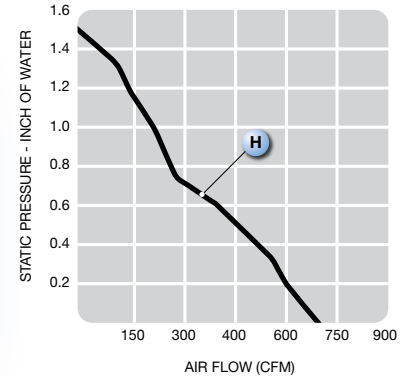
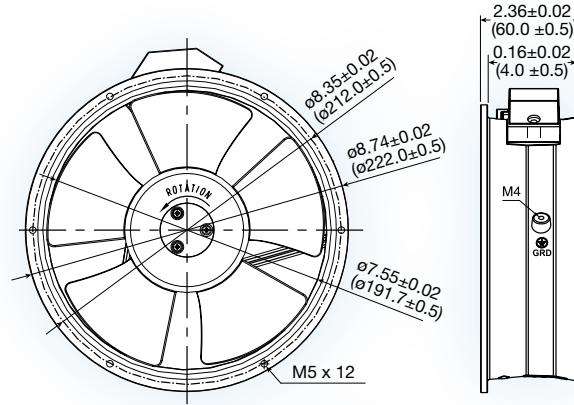

MM2260 series

**(222 dia. x 60 mm)**

8.74 dia. x 2.36 inches

Construction: magnesium alloy impeller & frame

Bearing option: ball bearing

Connection: terminal or AWG 18 lead wire

Frame: flanged

Protection: thermal

Options: tachometer output or locked rotor alarm signal

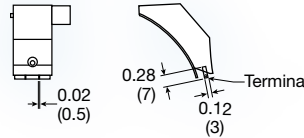

Model No.	Rated Voltage V	Current mA		Speed RPM	Air Volume		Max. Static Pressure (H ₂ O)		Sound Noise dbA	Weight kg
		24	48		M ³ /Min.	CFM	MM	INCH		
MM2260H	24/48	3000	1700	4,000	19	690	38.10	1.5	67	1.4