

## VERONICA-SQ-RS

~13° spot beam

### TECHNICAL SPECIFICATIONS:

Dimensions	Ø 22.5 mm
Height	12.2 mm
Fastening	tape, pin
Colour	clear
Box size	480 x 280 x 300 mm
Box weight	8.2 kg
Quantity in Box	1980 pcs
ROHS compliant	yes ⓘ



### MATERIAL SPECIFICATIONS:

Component	Type	Material	Colour
VERONICA-SQ-RS	Lens	PMMA	clear
VERONICA-TAPE	Tape	PU tape	clear

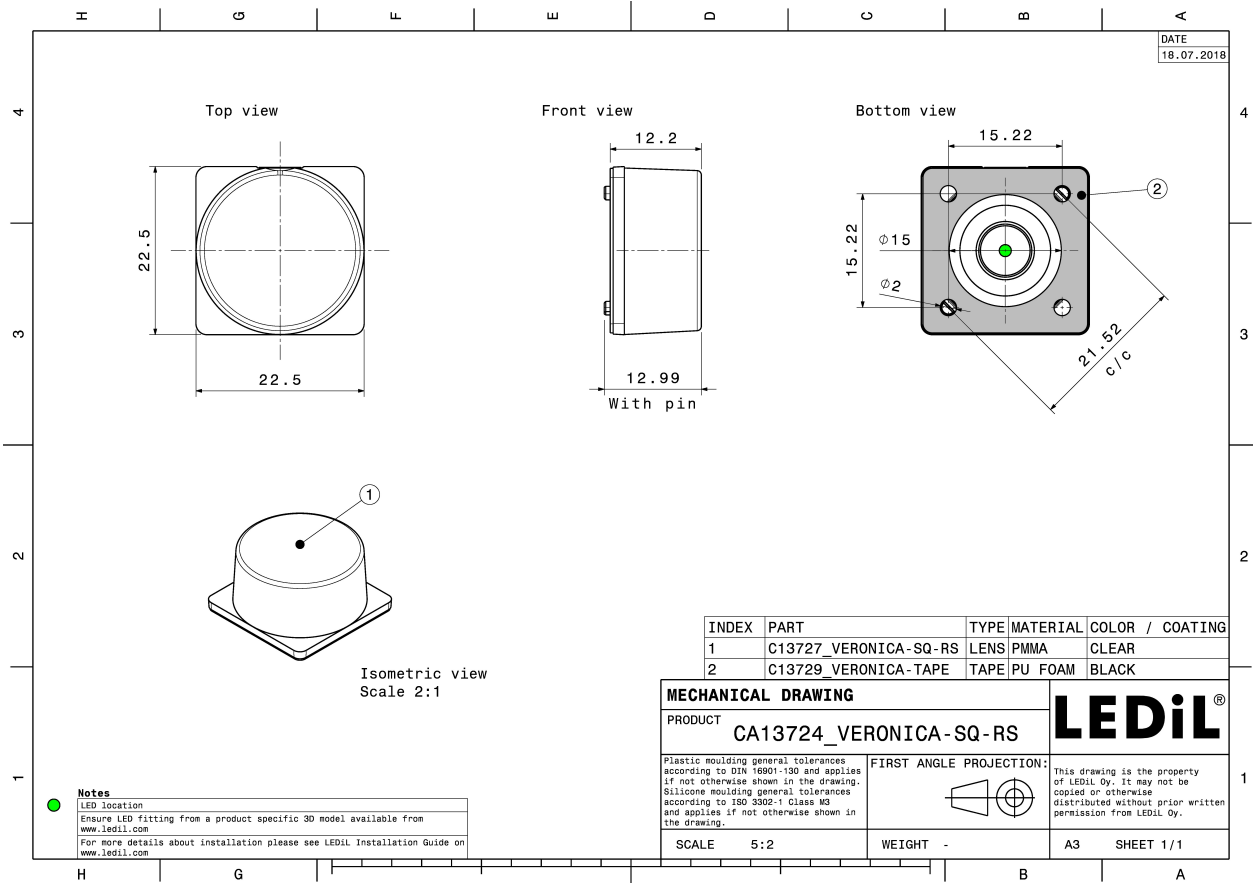

#### PHOTOMETRIC DATA (MEASURED):



LED XB-H  
 FWHM 12.0°  
 Efficiency 87 %  
 Peak intensity 16.000 cd/lm  
 Required components:

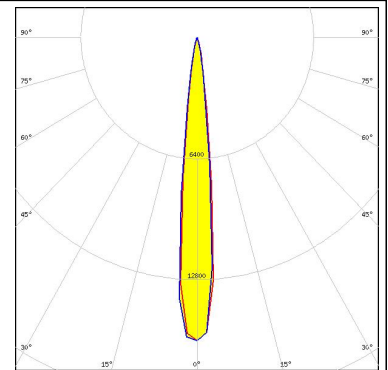
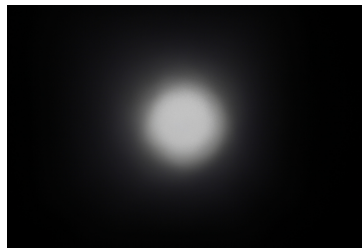

LED XP-G2  
 FWHM 11.0°  
 Efficiency 90 %  
 Peak intensity 18.800 cd/lm  
 Required components:

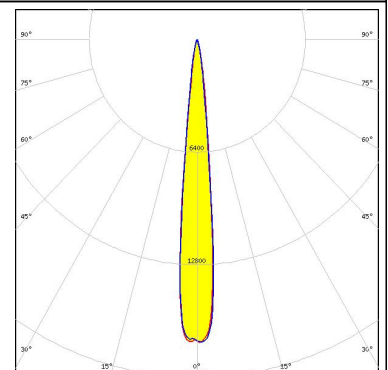

LED NWSx229A  
 FWHM 18.0°  
 Efficiency 88 %  
 Peak intensity 6.900 cd/lm  
 Required components:

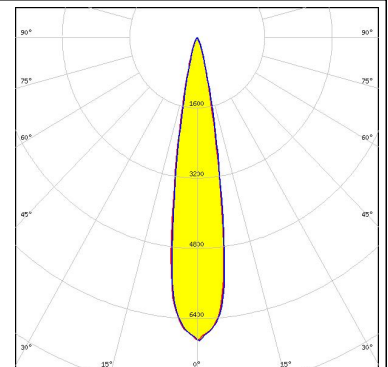
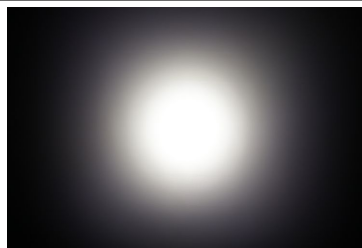

LED LH181A  
 FWHM 10.0°  
 Efficiency 93 %  
 Peak intensity 12.500 cd/lm  
 Required components:

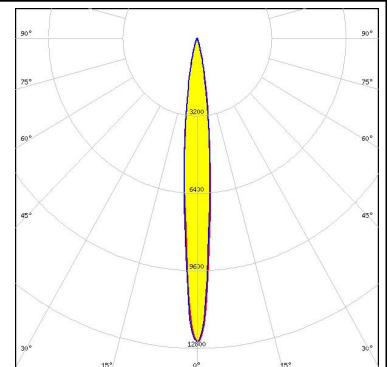

### PHOTOMETRIC DATA (MEASURED):

#### SAMSUNG

LED LH181B  
FWHM 10.0°  
Efficiency 94 %  
Peak intensity 15.800 cd/lm  
Required components:

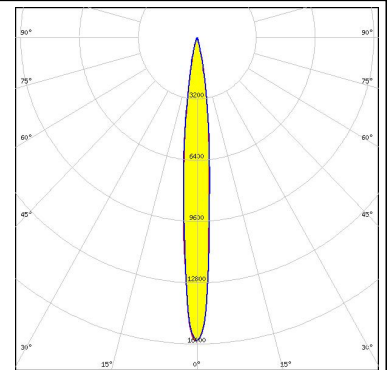
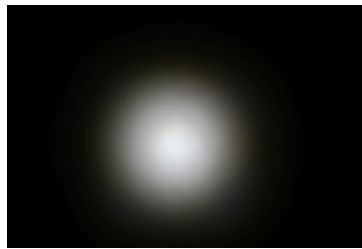

#### SAMSUNG

LED LH351Z  
FWHM 12.0°  
Efficiency 89 %  
Peak intensity 18.900 cd/lm  
Required components:

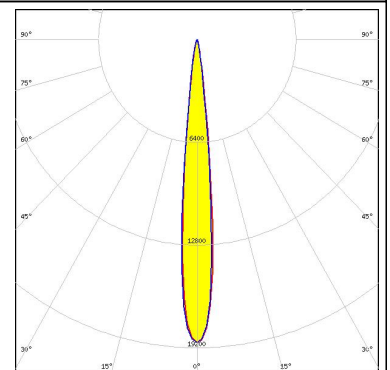
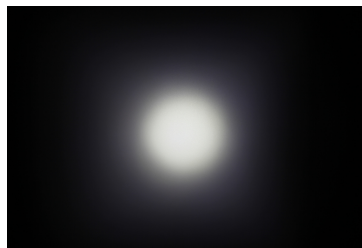

SEOUL SEMICONDUCTOR

LED Z8Y22P  
FWHM 12.0°  
Efficiency 86 %  
Peak intensity 1.100 cd/lm  
Required components:

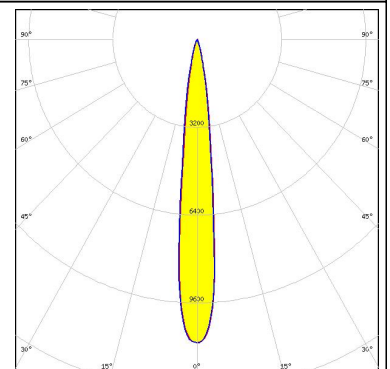
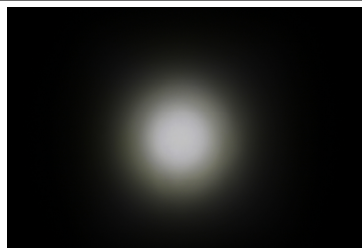

## PHOTOMETRIC DATA (SIMULATED):

### **CREE**

LED XM-L  
FWHM 15.0°  
Efficiency 91 %  
Peak intensity cd/Im  
Required components:

### **CREE**

LED XM-L2  
FWHM 15.0°  
Efficiency 92 %  
Peak intensity cd/Im  
Required components:

### **CREE**

LED XP-E  
FWHM 8.0°  
Efficiency 92 %  
Peak intensity cd/Im  
Required components:

### **CREE**

LED XP-E2  
FWHM 8.0°  
Efficiency 92 %  
Peak intensity cd/Im  
Required components:

### PHOTOMETRIC DATA (SIMULATED):

#### CREE

LED XP-G  
FWHM 10.0°  
Efficiency 92 %  
Peak intensity cd/lm  
Required components:

#### CREE

LED XT-E  
FWHM 10.0°  
Efficiency 90 %  
Peak intensity cd/lm  
Required components:

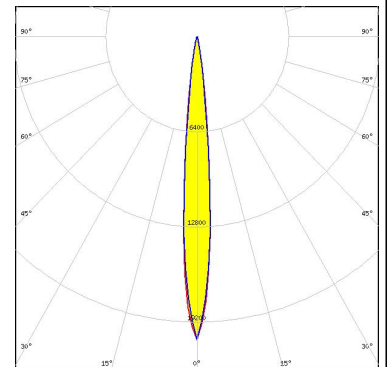

#### LUMILEDS

LED LUXEON 3030 HV  
FWHM 10.0°  
Efficiency 94 %  
Peak intensity 20.970 cd/lm  
Required components:

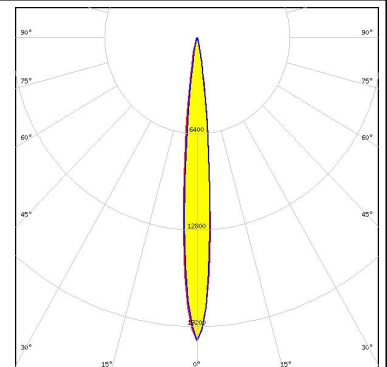

#### LUMILEDS

LED LUXEON A  
FWHM 11.0°  
Efficiency 90 %  
Peak intensity cd/lm  
Required components:

### PHOTOMETRIC DATA (SIMULATED):

#### LUMILEDS

LED LUXEON R  
FWHM 11.0°  
Efficiency 90 %  
Peak intensity cd/lm  
Required components:

#### LUMILEDS

LED LUXEON Rebel  
FWHM 9.0°  
Efficiency 90 %  
Peak intensity cd/lm  
Required components:

#### LUMILEDS

LED LUXEON Rebel ES  
FWHM 11.0°  
Efficiency 90 %  
Peak intensity cd/lm  
Required components:

#### LUMILEDS

LED LUXEON V  
FWHM 17.0°  
Efficiency 94 %  
Peak intensity 7.600 cd/lm  
Required components:

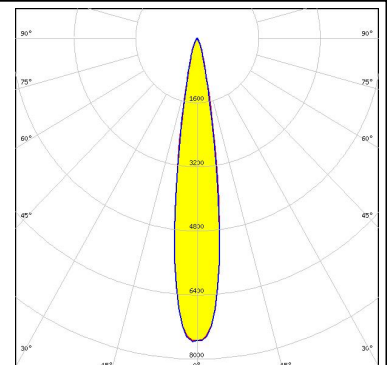

#### PHOTOMETRIC DATA (SIMULATED):



LED NCSxx19A  
FWHM 8.0°  
Efficiency 88 %  
Peak intensity cd/lm  
Required components:



LED NVSxE21A  
FWHM 9.4°  
Efficiency 94 %  
Peak intensity 20.600 cd/lm  
Required components:

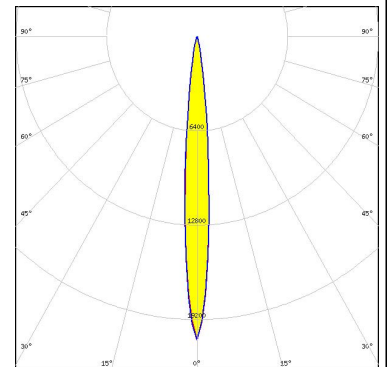

LED NVSxx19B/NVSxx19C  
FWHM 11.0°  
Efficiency 89 %  
Peak intensity cd/lm  
Required components:



LED Oslon Square EC  
FWHM 10.0°  
Efficiency 94 %  
Peak intensity 20.200 cd/lm  
Required components:

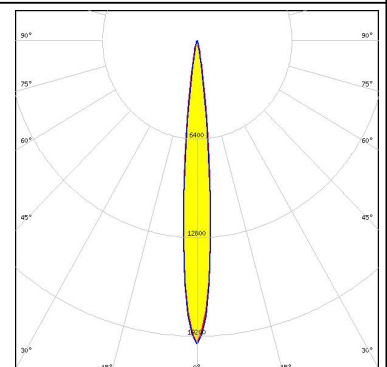



#### PHOTOMETRIC DATA (SIMULATED):

**OSRAM**  
Opto Semiconductors

LED Oslon Square Gen3  
FWHM 10.0°  
Efficiency 94 %  
Peak intensity 20.800 cd/lm  
Required components:

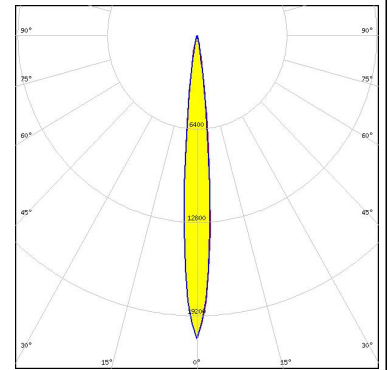

**OSRAM**  
Opto Semiconductors

LED Oslon Square PC  
FWHM 10.0°  
Efficiency 90 %  
Peak intensity cd/lm  
Required components:

**OSRAM**  
Opto Semiconductors

LED Oslon SSL 150  
FWHM 8.0°  
Efficiency 91 %  
Peak intensity cd/lm  
Required components:

**OSRAM**  
Opto Semiconductors

LED Oslon SSL 80  
FWHM 7.0°  
Efficiency 90 %  
Peak intensity cd/lm  
Required components:

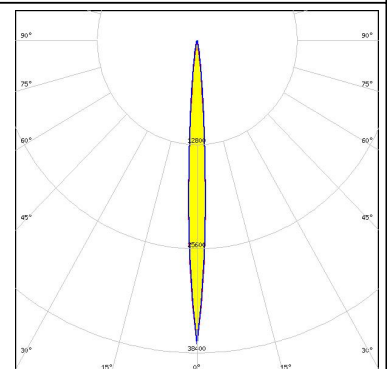

#### PHOTOMETRIC DATA (SIMULATED):

#### SAMSUNG

LED LH181B  
FWHM 11.0°  
Efficiency 94 %  
Peak intensity 17.000 cd/lm  
Required components:

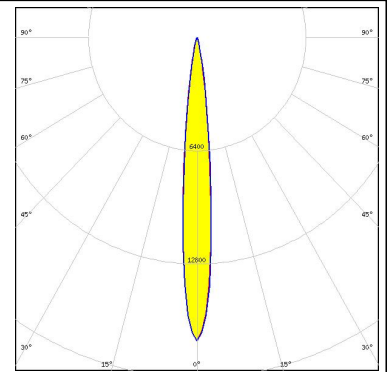

#### SAMSUNG

LED LH351B  
FWHM 12.0°  
Efficiency 93 %  
Peak intensity cd/lm  
Required components:

#### GENERAL INFORMATION:

NOTE: The typical beam angle will be changed by different color, chip size and chip position tolerance. The typical total beam angle is the full angle measured where the luminous intensity is half of the peak value.

#### MATERIALS:

As part of our continuous research and improvement processes, and to ensure the best possible quality and availability of our products, LEDiL reserves the right to change material grades without notice.

#### PRODUCT DATA USER AGREEMENT AND DISCLAIMER:

The measured data in the provided downloadable LEDiL Product Datasheets and Mechanical 2D-Drawings is rounded and provided as reference for planning. LEDiL Oy's optical specifications have been verified by conducting performance testing of the products in accordance with the company's quality system. The reported data are averaged results of multiple measurements with typical variation. LEDiL Oy reserves the right to without prior notification make changes and improvements to its products.

LEDiL Oy assumes neither warranty, nor guarantee nor any other liability of any kind for the contents and correctness of the provided data. The provided data has been generated with highest diligence but the provided data may in reality not represent the complete possible variation range of all intrinsic parameters. Therefore, in certain cases a deviation from the provided data could occur.

LEDiL Oy reserves the right to undertake technical changes of its products without further notification which could lead to changes in the provided data. LEDiL Oy assumes no liability of any kind for the possible deviation from any provided data or any other damage resulting from the usage of the provided data.

The user agrees to this disclaimer and user agreement with the download or usage of the provided files.

#### LEDiL Oy

Joensuunkatu 13  
FI-24240 SALO  
Finland

#### LEDiL Inc.

228 West Page Street  
Suite D  
Sycamore IL 60178  
USA

#### Local sales and technical support

[www.ledil.com/  
where\\_to\\_buy](http://www.ledil.com/where_to_buy)

#### Shipping locations

Salo, Finland  
Hong Kong, China

#### Distribution Partners

[www.ledil.com/  
where\\_to\\_buy](http://www.ledil.com/where_to_buy)